

Technology Art Sound
Manufactured by
elettromeia italy



ML Power

ADVANCED WEB MANUAL

ML Power 1
rev 1.0 c

The User Manual is also
available from our web site
www.hertzaudiovideo.com

www.hertzaudiovideo.com

HERTZ
The Sound Experience

Index

1. INTRODUCTION	3
2. PACKAGE CONTENTS	3
3. SAFE SOUND	4
4. GENERAL PRECAUTIONS	5
5. INSTALLATION AND SIZE	6
6. BATTERY / REMOTE CONNECTION AND HOW TO REPLACE THE FUSE	7
7. AUTO TURN-ON WITH HI-LEVEL INPUTS	7
8. TOP PANEL CONTROLS: SWITCHES AND ADJUSTMENT CONTROLS	8
9. FRONT AND REAR PANELS	9
10. CONFIGURATION DIAGRAMS	
HOW TO USE REMOTE VOLUME CONTROL	11
PRE-IN FOR ONE SUBWOOFER	11
PRE-IN FOR TWO SUBWOOFERS	12
HI-IN INPUT	13
HI-IN INPUT AND PRE-OUT	14
PRE-IN FROM PROCESSOR OUTPUT	15
11. CABLES	16
12. BLOCK DIAGRAM	17
13. TECHNICAL SPECIFICATIONS	18

1 INTRODUCTION

Thank you for purchasing a Hertz product, designed according to the highest quality standards.



Your ML Power amplifier is a cutting-edge product of compact size, providing high power and quality of sound.

It will definitely ensure you maximum satisfaction by taking up very small room in your vehicle.

Before the installation, in addition to reading the Quick Start Guide (QSG), the consultation of this user's manual available on the Hertz website will let you achieve the highest performance from your amplifier.

2. PACKAGE CONTENTS

In the package, besides your amplifier, you will find:

- Quick Start Guide 
 - Warranty Card 
 - 40 A blade fuse  x3
 - 4,2 x 16 mm self-tapping, cross-headed fixing screws  x4
- OPTIONAL**
- HRC BM: SUB volume control 

3. SAFE SOUND

HERTZ AMPLIFIERS CAN BE PART OF A HIGH POWER AUDIO SYSTEM THAT CAN GENERATE VERY HIGH UNDISTORTED SOUND PRESSURE LEVELS. PLEASE REMEMBER THAT LONG EXPOSURE TO AN EXCESSIVELY HIGH SOUND PRESSURE LEVEL MAY DAMAGE YOUR HEARING; THEREFORE, PLEASE USE COMMON SENSE AND PRACTICE SAFE SOUND.

Safety must be at the forefront while driving. The listening volume should never obscure the noise coming from the outside of your vehicle; you should be able to hear the sounds generated by your vehicle in order to promptly face any emergency situation.

To achieve the best possible performance from your new components, we recommend you follow the instructions in this manual carefully. In order to design and create top level car hi-fi systems you need to understand automobile mechanical and electrical issues very well; if you think you lack the required knowledge or the proper tools, please consult with a specialized installer.

A professional installation will ensure your system delivers all the performance you have paid for, without affecting the safety and reliability of your vehicle.

This manual has been designed to provide you with the basic instructions required to install and use this product. However, the range of possible applications is very wide; to obtain further information, please contact your authorized Hertz dealer or Hertz service center.

You can also send an e-mail directly to the following addresses:

Italy - supporto.tecnico@elettromedia.it

Worldwide - support@elettromedia.it

4. GENERAL PRECAUTIONS

- This symbol indicates that you have to pay attention to these instructions. Disregarding them might cause accidental harms or damage your amplifier.
- Before installing the amplifier, make sure you carefully read and understand all instructions.
- The vehicle electric system must have 12V DC voltage with negative to ground. Make sure your car has it in order to avoid any damages to your amplifier and to the vehicle.
- Pre-plan the configuration of your new amplifier and the best wiring routes to ease installation.
- Always wear protective eyewear when using tools that may generate splinters.
- During installation, keep the amplifier in its packing as long as possible; this will protect it from damages.
- Secure all auxiliary devices you built to install the components to the vehicle structure through brackets, screws, nuts and bolts; this insures stability and safety while driving.
- The amplifier detachment while driving can damage the people in the vehicle and other cars. Secure the amplifier at best, paying utmost attention if installation is inside the passenger's compartment. Do not carry out any installation inside the engine compartment.
- Before installing the amplifier, turn off the source and all other electronic devices in the audio system for preventing any damages.
- Make sure the location you chose for the components does not affect the correct functioning of the vehicle mechanic and electric devices.
- Do not run the cables or install the amplifier next to electronic gearcases.
- Use extreme caution when cutting or drilling the car plate, checking there are no electrical wiring or structural element underneath.
- Before connecting the power cable to the amplifier, disconnect the negative lead (-) from the car battery.
- Make sure power cable is not short circuited during installation and connection.
- Power cable must have mechanically resistant and self-extinguishing insulation. Its section have a size corresponding with what is suggested in this manual. Avoid to run it over or through sharp edges or close to moving mechanical devices. Make sure it is well fixed all along its length. Block positive and negative cables just close to the amplifier respective power supply terminal blocks through a clamping screw.
- Use rubber grommets to protect the wire if it runs in a hole of the plate or proper materials if it is close to heat-generating parts.
- To ground the device (-) in the right way, use a screw in the vehicle chassis; scrape all paint or grease from the metal if necessary, checking with a tester that there is continuity between the battery negative terminal (-) and the fixing point. If possible, connect all components to the same ground point; this solution rejects most noise.
- Route all signal cables away from power cables.
- Never run cables outside the vehicle; you would not be protected against wear and in case of accidents.
- When installing speakers and the cables that connect them, make sure that non-insulated parts never touch, even occasionally, the vehicle cutting parts. If they do, the amplifier protection is activated.
- To prevent all problems, use very good quality cables, connectors and accessories, choosing them in Connection catalogue.
- When installation is over, and before plugging the main power supply fuse, check the system wiring and make sure all connections were done in the right way.
- Power amplifiers put an increased load on the battery and on its charging system. We recommend checking your alternator and battery condition to ensure they can handle the increased consumption. Standard electrical systems which are in good condition should be able to stand this extra load without problems but we recommend the use of an energy storage capacitor and/or a battery for high level audio systems.
- Put a fuse and its insulated fuse holder 40 cm max. far from the battery positive terminal; connect one end of the power cable to it after connecting the other end to the amplifier. The fuse value must be 50% higher than the amplifier built-in one. In case the cable supplies several amplifiers, the fuse value will have to be 50% higher than the sum of the values of all other fuses in the amplifiers.
- There must be good air circulation where the amplifier is installed; this area must not be affected by humidity, rain, external deposits or parts coming from the vehicle mechanical devices. Do not hinder in any way the cooling of the amplifier side fins
- Install the amplifier in the vehicle parts where temperature is between 0°C (32°F) and 55°C (131°F).



WARNING: When working in demanding conditions, the amplifier can reach temperatures of around 80 - 90°C (176- 194°F). Make sure it is not dangerously hot before touching it.

- Periodically clean the amplifier without using aggressive solvents that might damage it. Dampen a piece of cloth with water and soap, wring it and clean the amplifier. Then use a piece of cloth dampened with water only; eventually clean the amplifier with a dry piece of cloth.
- Remove dust and solid deposits from the heat sink side fins. Don't use compressed air on the amplifier since it would push solid parts in the amplifiers. If necessary, please contact a specialised service centre for internal cleaning. Cooling system obstruction makes the amplifier go in safety mode.

5. INSTALLATION AND SIZES

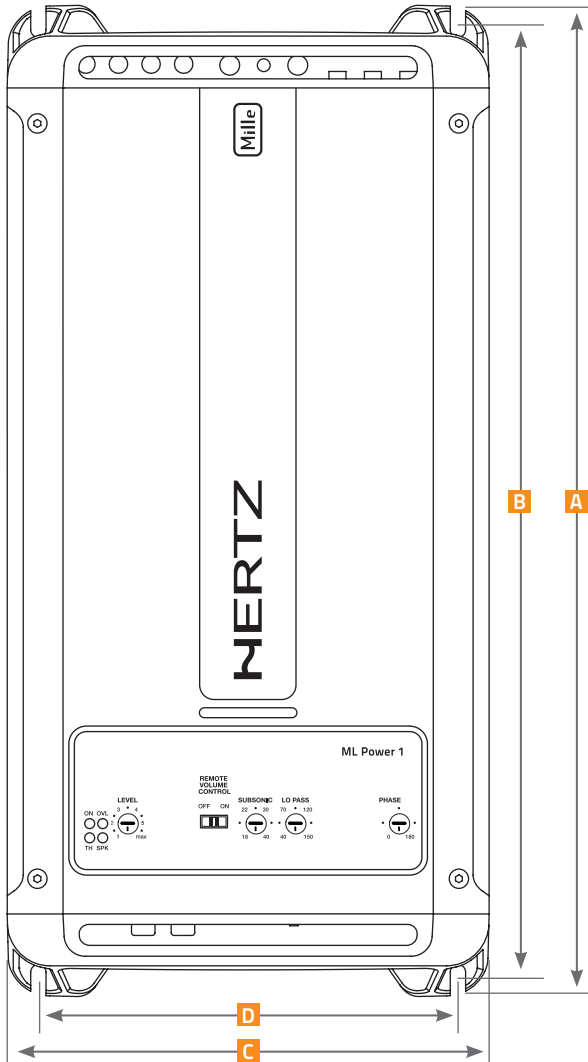

	A	B	C	D	E	
ML Power 1	349	332	170	148	46,7	mm
	13.74	13.07	6.69	5.83	1.84	in.

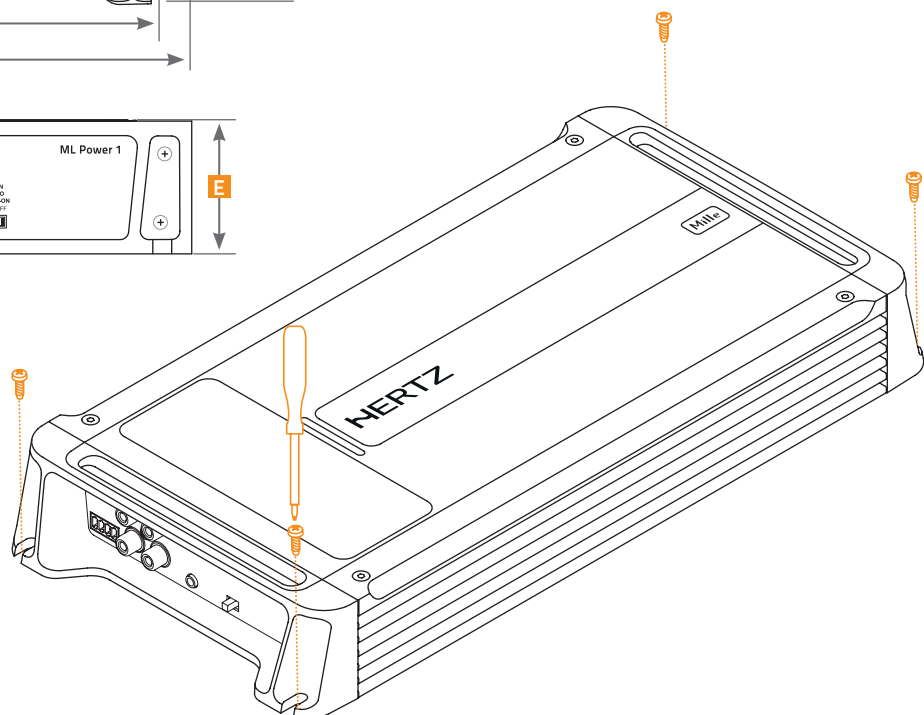
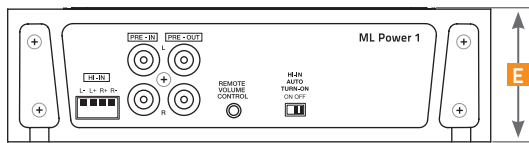

6. BATTERY / REMOTE CONNECTION AND HOW TO REPLACE THE FUSE

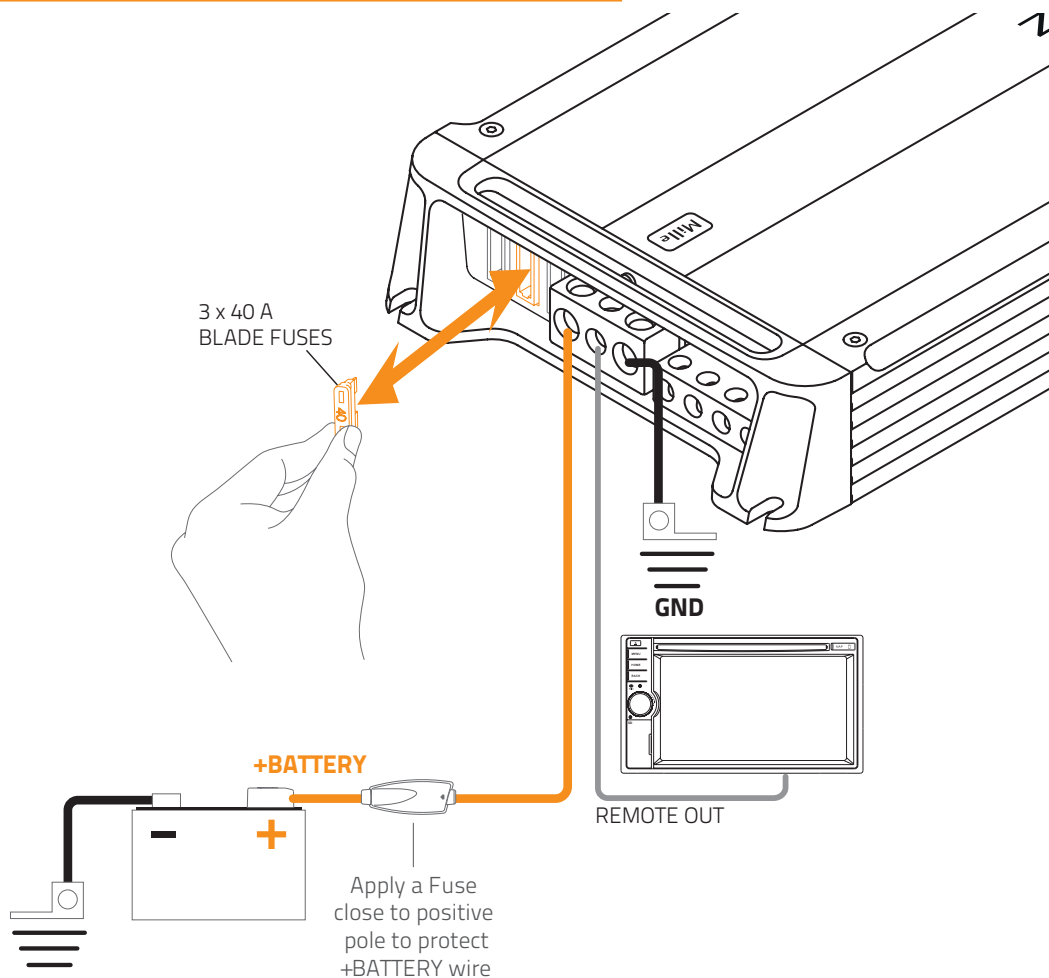

7. AUTO TURN-ON WITH HI-LEVEL INPUTS

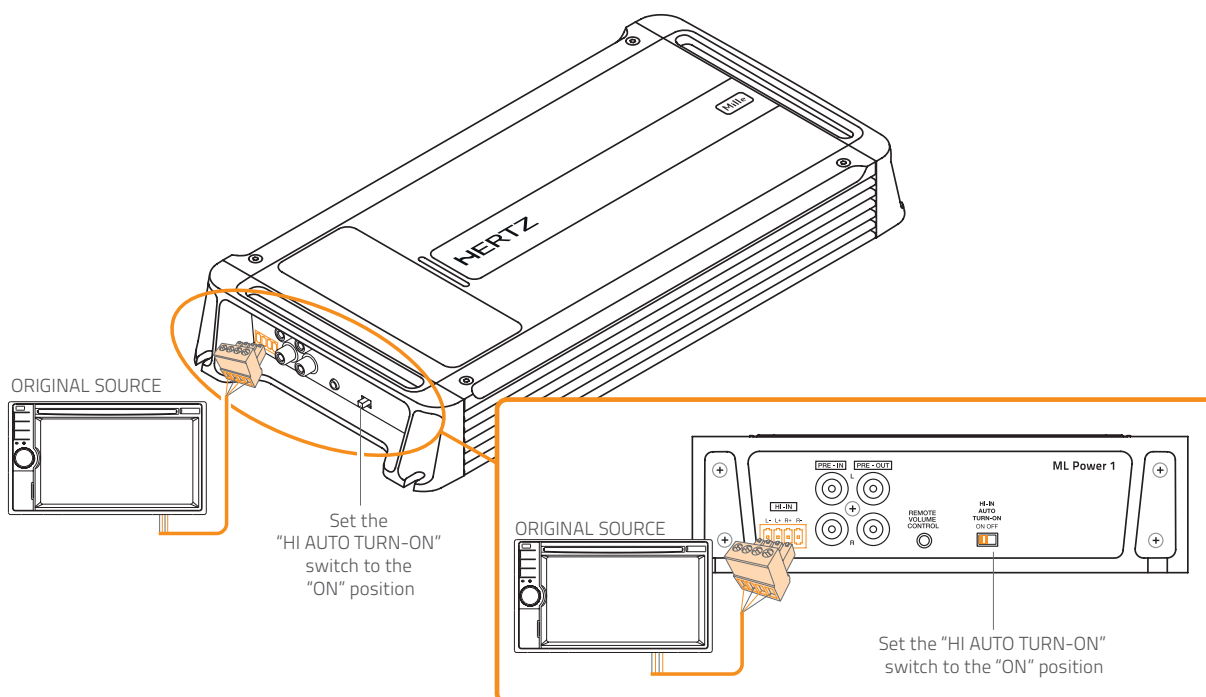

8. TOP PANEL CONTROLS: SWITCHES AND ADJUSTMENT CONTROLS

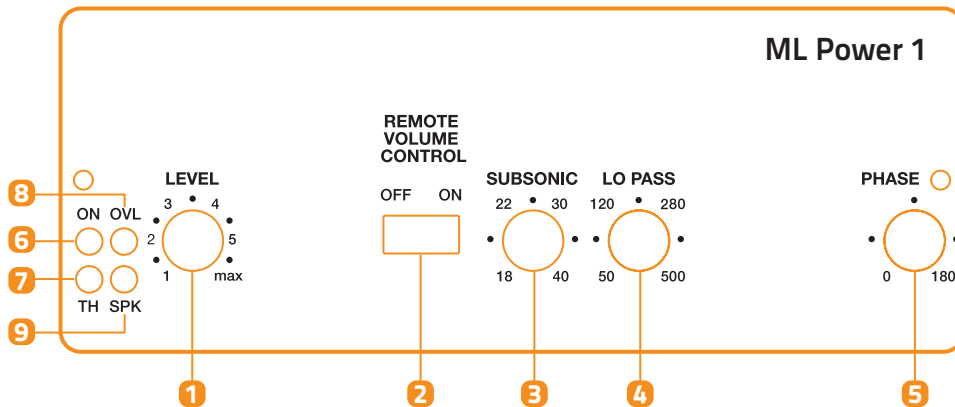

- 1 LEVEL: Input sensitivity adjustment control.** Set to 1 position. Use a CD as source, increase head unit volume until output distorts, then decrease volume by 1 step in order to eliminate distortion. Turn LEVEL up until sound becomes distorted, then turn LEVEL down a bit for optimum sound.
- 2 REMOTE VOLUME CONTROL (ON - OFF):** Activate **ON** or deactivate **OFF** external remote volume control. Connect external adjustment control to front panel proper connectors.
- 3 SUBSONIC: (18 Hz ÷ 40 Hz): Crossover point (Hi-Pass filter) adjustment.** Rotating the knob you can select any frequency between 18Hz and 40Hz. The frequencies below the crossover point will be attenuated at 24dB/Oct. This control is useful to remove ultra-low frequencies present in some audio signals which do not contribute to music information and might cause distortion or abnormal warming.
- 4 LO-PASS (50 Hz ÷ 500 Hz): Crossover point adjustment.** Rotating the knob you can select any frequency between 50Hz and 500Hz. The frequencies above the crossover point will be attenuated at 24dB/Oct.
- 5 PHASE (0° ÷ 180°): Phase signal rotation point adjustment.** Rotating the knob you can select any phase angle between 0° and 180° (phase reversal). The PHASE angle is centered at 80Hz. For frequency beyond or below this value, phase angle decreases. While listening to the front loudspeaker (driven from other amplifier), adjust PHASE in order to have a good bass response.
- 6 ON: Power LED.** It lights up when you turn on the amplifier. If all LEDs (6) (7) (8) (9) turn on at the same time, the amplifier will shut down and you will have to contact a service centre.
- 7 TH: Terminal status LED.** It lights up when thermal protection is active, above 85°C. The amplifier shuts down until the chassis temperature goes below 75°C.
- 8 OVL: Overload status LED.** It lights up when overload occurs on the power output terminals. The amplifier goes in muting for 3 seconds and this LED starts flashing until you turn off the amplifier. **REMOVE THE CAUSE OF OVERLOAD.**
- 9 SPK: Speaker status LED.** It lights up when a speaker touches the car body. The amplifier goes in muting for 3 seconds and this LED starts flashing until you turn off the amplifier. **REMOVE THE CONTACT BETWEEN SPEAKER WIRE AND CAR BODY.**

9. FRONT AND REAR PANELS

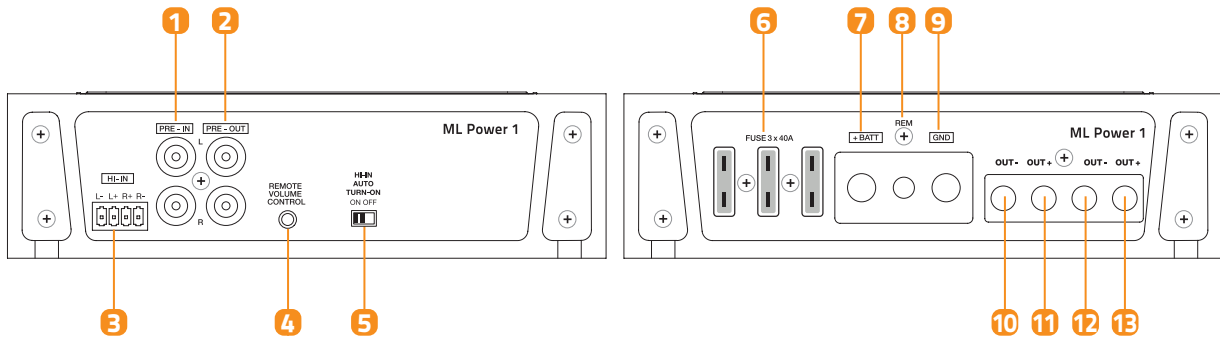

- 1 PRE-OUT** This jack provide Left and Right pre-amplified outputs to drive a separate amplifier. These signals are full range, without crossover action.
- 2 PRE-IN:** Left and Right pre-amplified inputs. Drive power output with L and R mixed signal. Connect to pre-amplified source output. Signal can be 0.2 to 5V RMS.
- 3 HI-IN:** Hi-Level signal Left and Right inputs. If the head unit does not feature a pre-amplified output, connect here its speaker wire to drive Left and Right channels. Signal can be 0.8 to 20V RMS.
- 4 REMOTE VOLUME CONTROL:** Input for REMOTE SUB VOLUME CONTROL. Connect here the adjustment control that the amplifier features (optional).
- 5 HI-IN AUTO TURN-ON (ON - OFF):** Select **ON** to turn on the amplifier through the speaker power cable, if the source does not feature a 12V DC REMOTE OUT. Select **OFF** if REMOTE OUT from the source is available.
- 6 PROTECTION FUSE:** 3 x 40A
- 7 POWER (+ BATT):** Terminal block for the amplifier 11 ÷ 15V DC power supply positive pole connection. Insert here the battery positive cable. The plug accepts cables up to 2 A.W.G.
- 8 REMOTE IN:** REMOTE IN terminal for the remote cable coming from the device which turns on the amplifier. Voltage must be between 7 and 16V DC.
- 9 POWER (GND):** Terminal block for the amplifier power supply negative pole connection. Insert here the battery negative cable or wire connected to the vehicle chassis. The plug accepts cables up to 2 A.W.G.
- 10 OUT - Speaker OUT:** Negative power terminal, connect to negative speaker terminal.
- 11 OUT + Speaker OUT:** Positive power terminal, connect to positive speaker terminal.
- 12 OUT - Speaker OUT:** Negative power terminal (same output as nr.10), connect to negative terminal of second speaker if needed.
- 13 OUT + Speaker OUT:** Positive power terminal (same output as nr.11), connect to positive terminal of second speaker if needed.

10. CONFIGURATION DIAGRAMS

HOW TO USE REMOTE VOLUME CONTROL

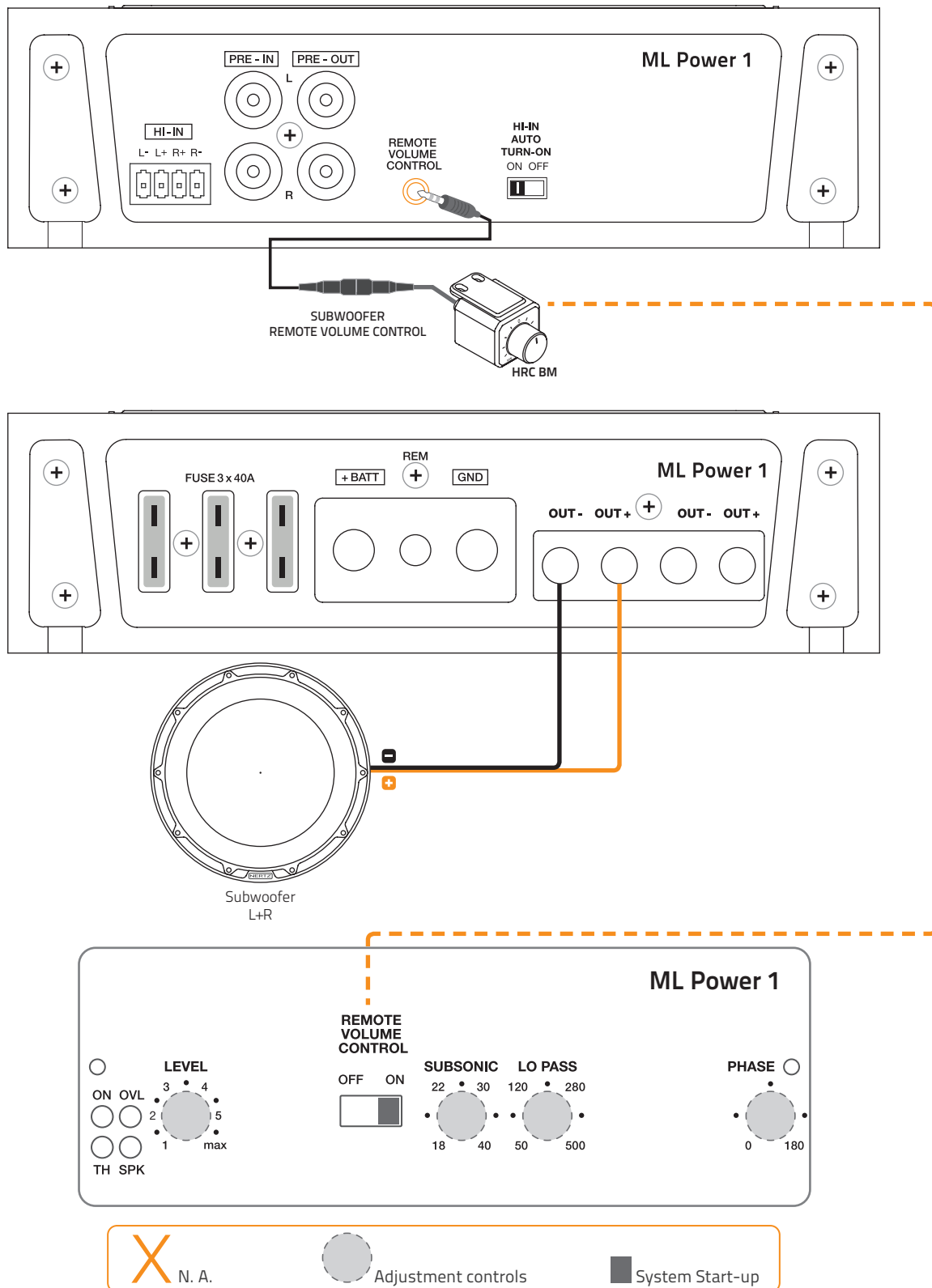

PRE-IN FOR ONE SUBWOOFER

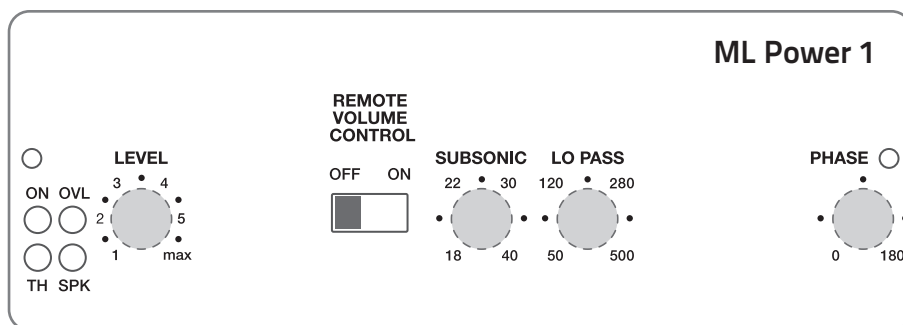
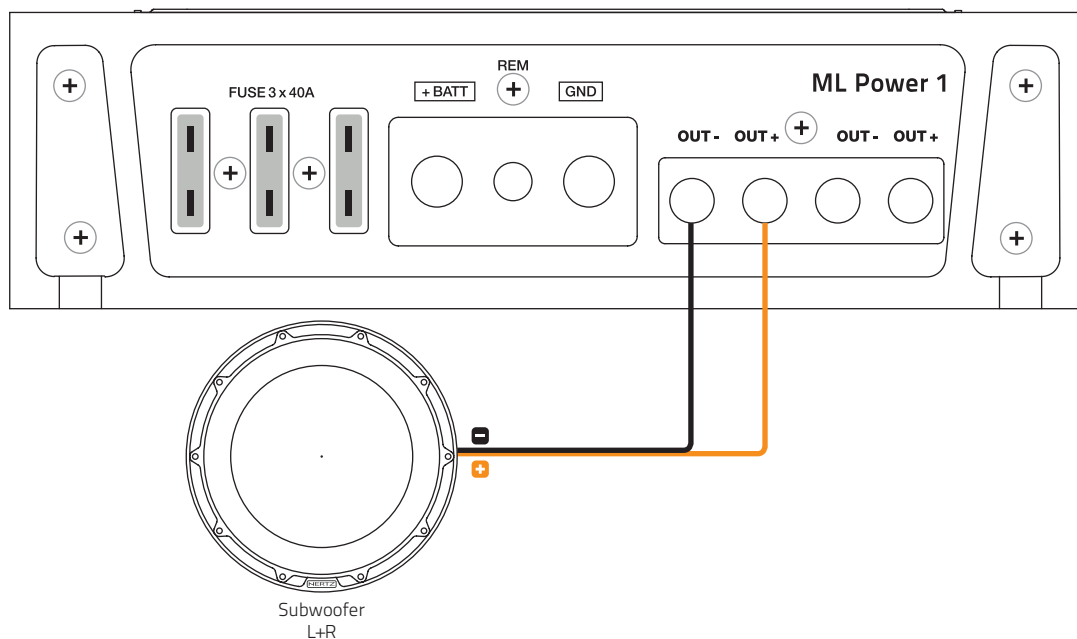
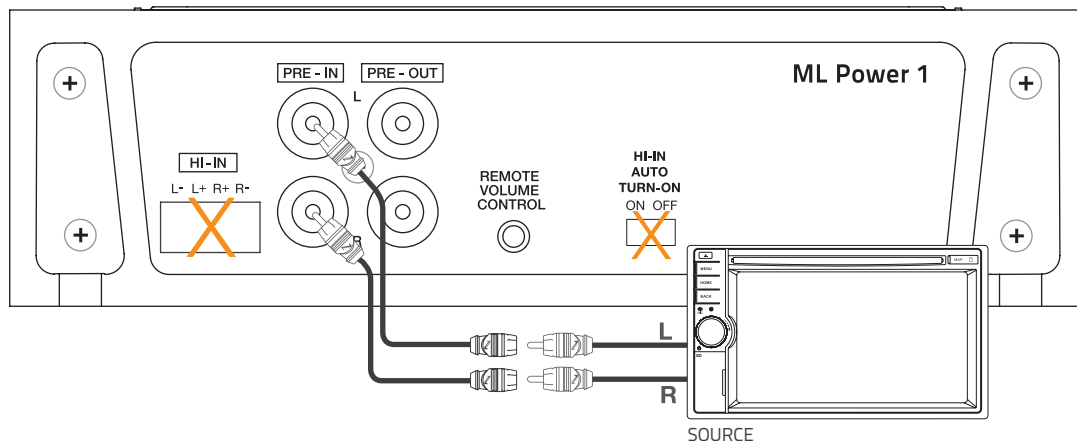

X N. A.
● Adjustment controls
■ System Start-up

PRE-IN FOR TWO SUBWOOFER

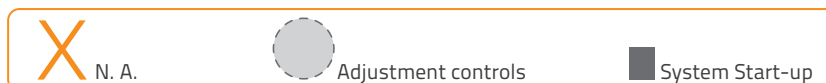
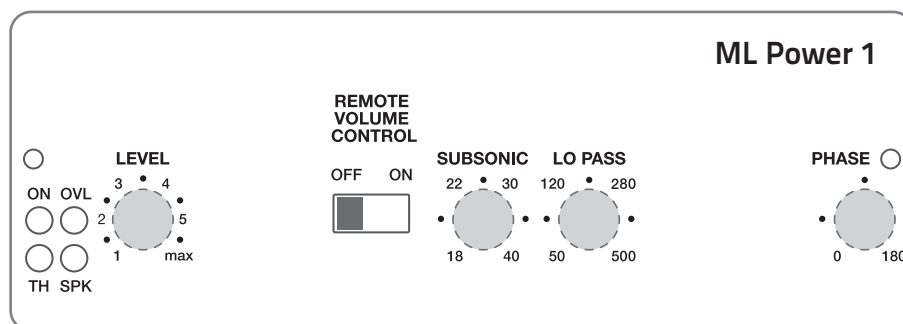
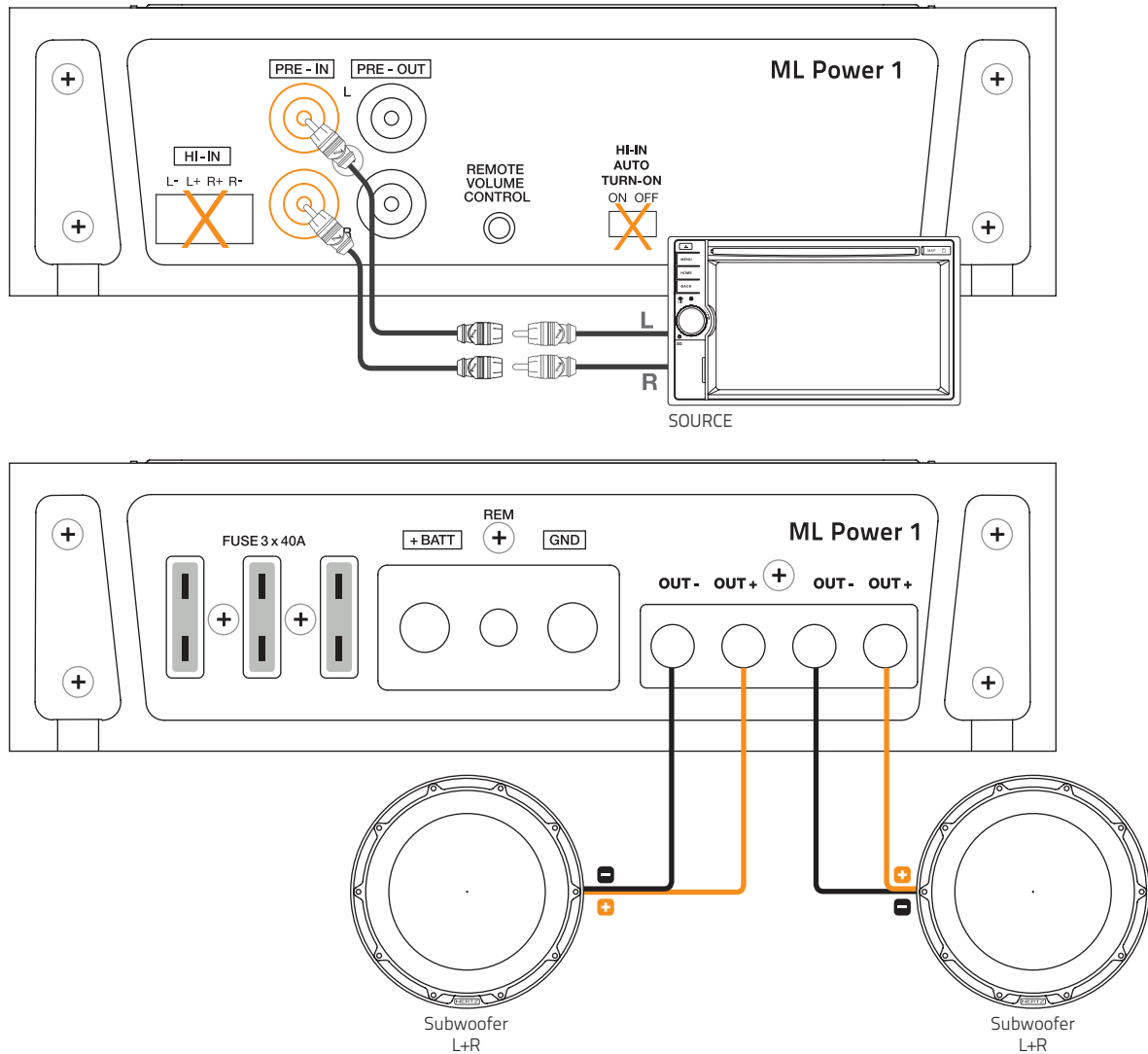

HI-IN INPUT

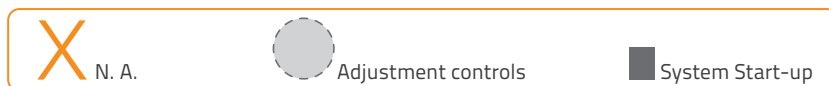
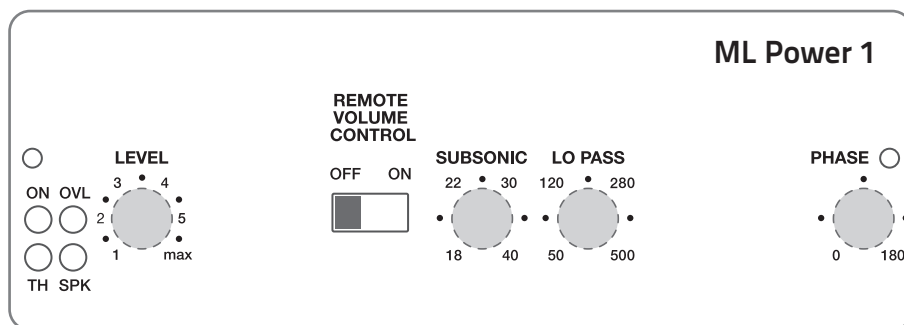
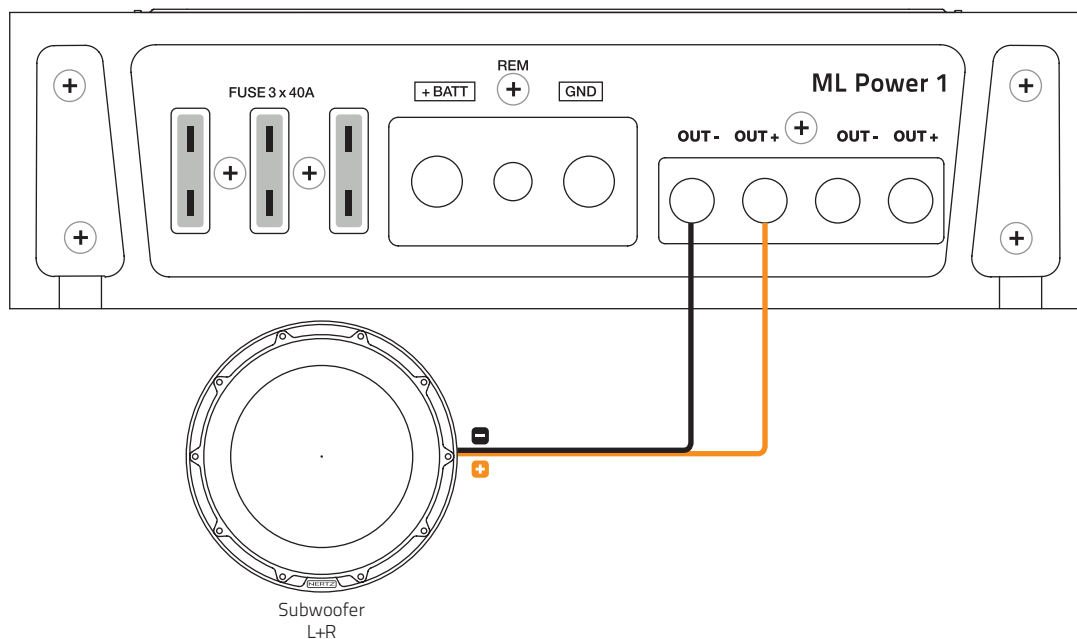
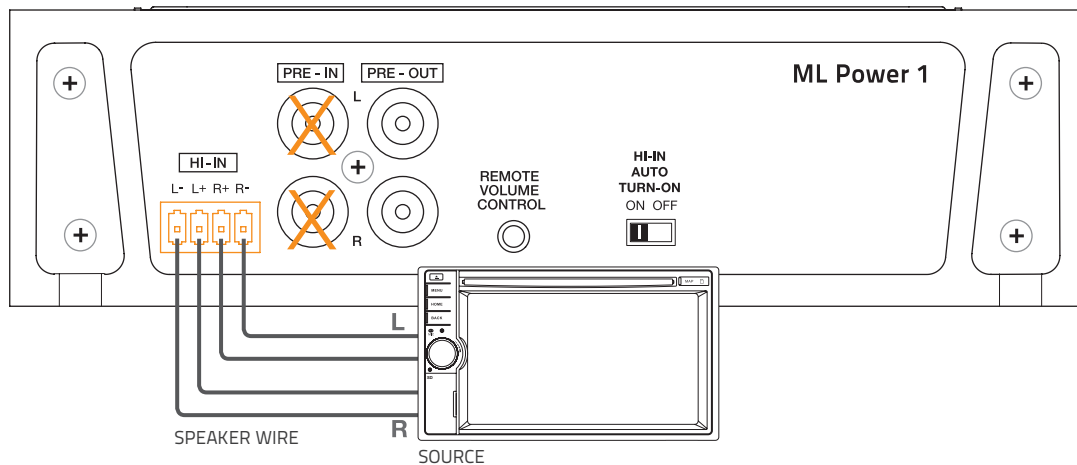

HI-IN INPUT AND PRE-OUT

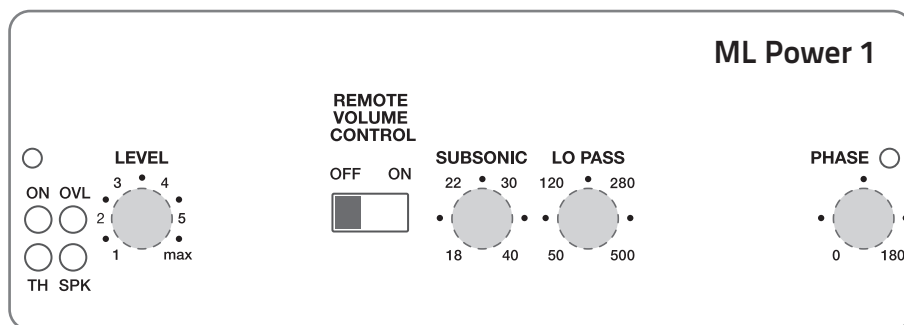
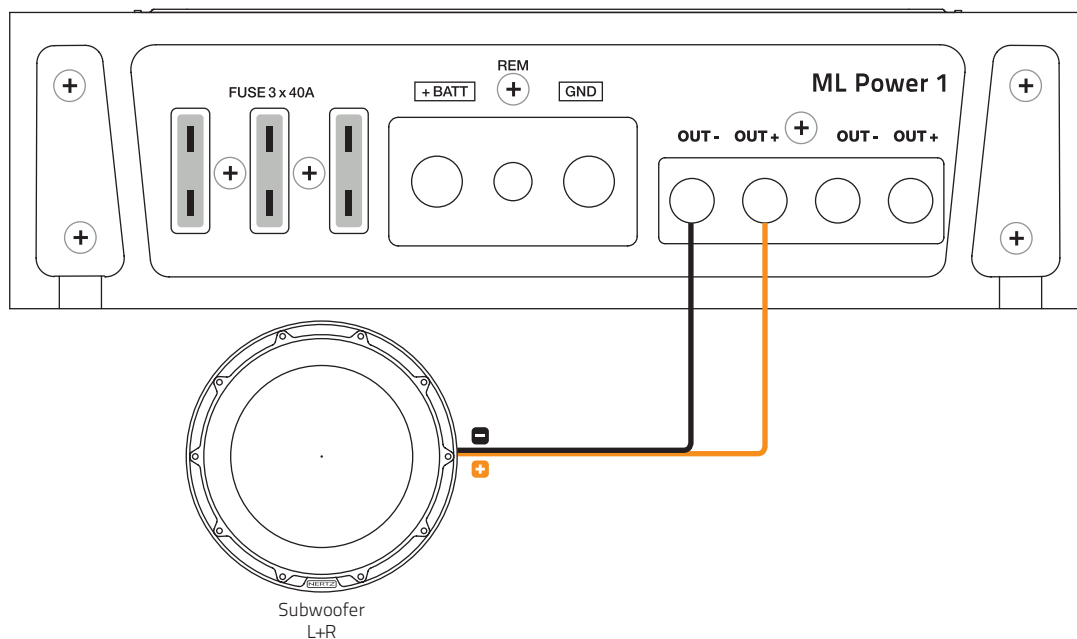
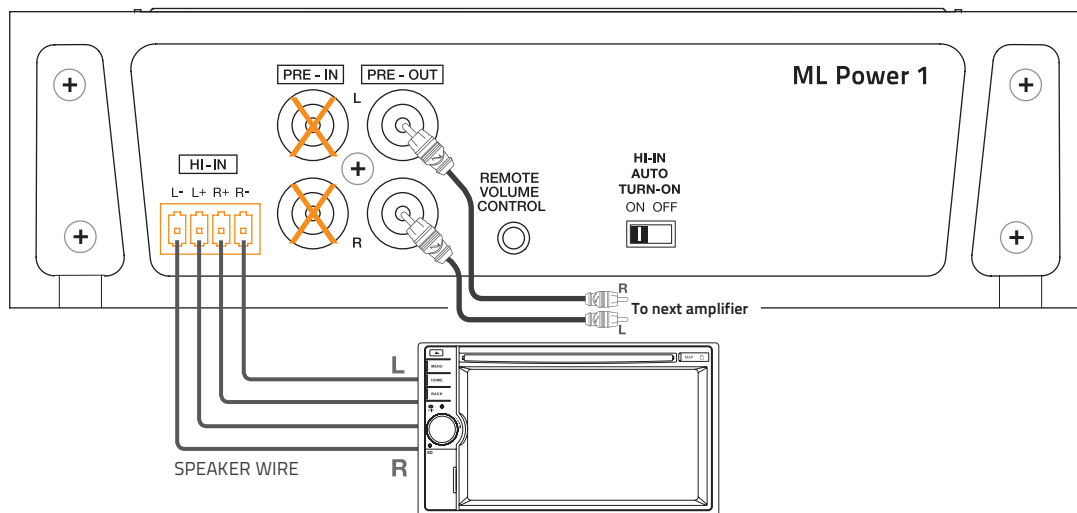

X N. A.
● Adjustment controls
■ System Start-up

PRE-IN FROM PROCESSOR OUTPUT

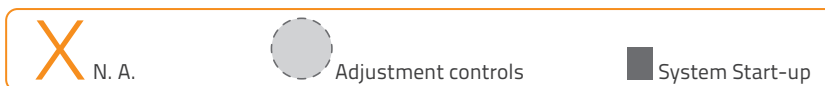
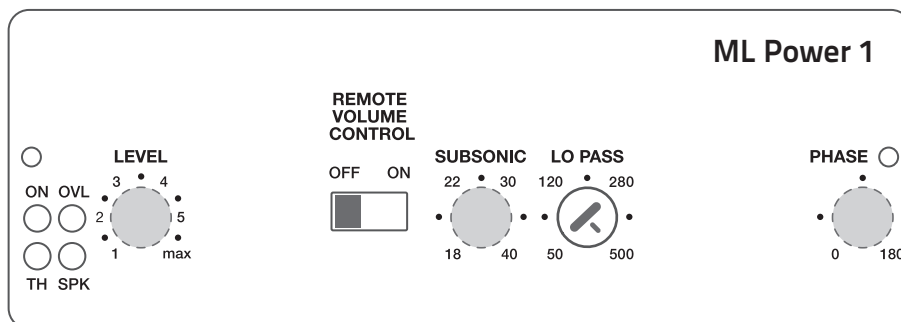
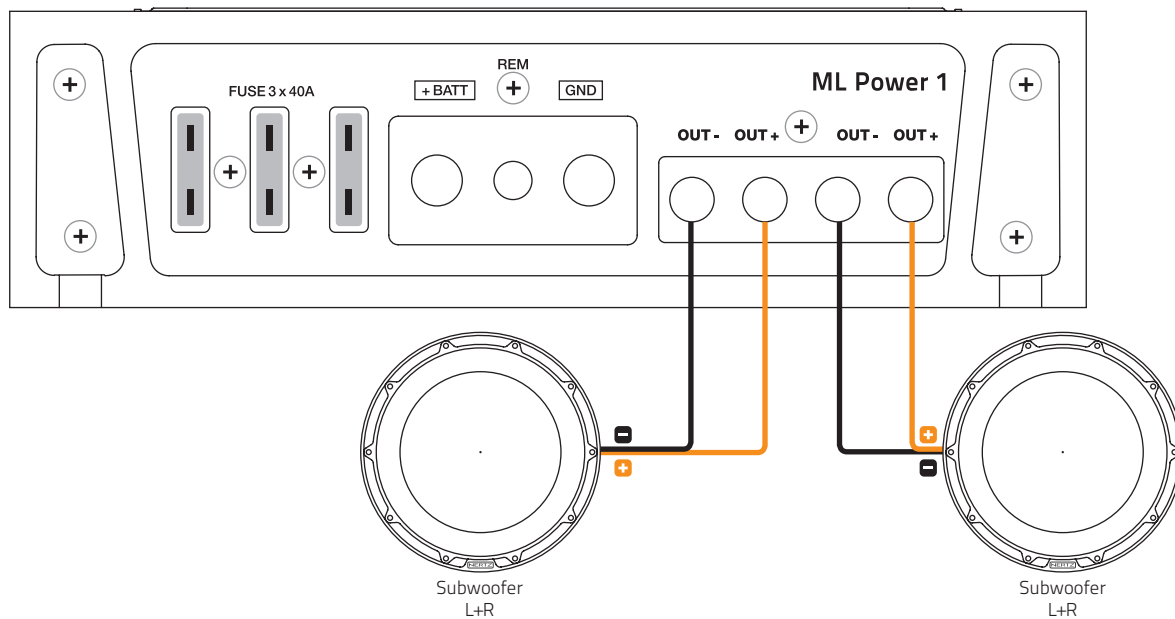
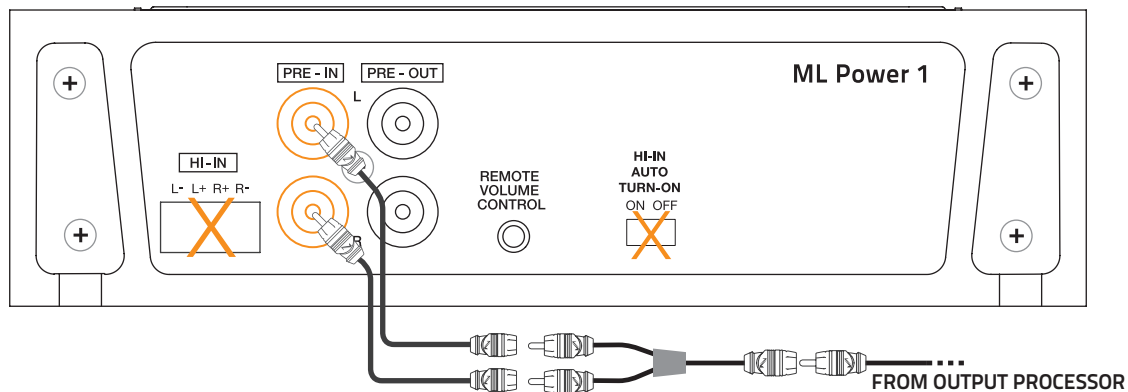

11. CABLES

Connection cables

For maximum performance, always use new, good quality cables; their outer jacket must not be spoiled, and the copper must not show oxidation. For proper operation, always consider the length of the connection, the load and the current it has to handle. Connection products are the most flexible and complete; they are designed and built in order to get the best out of every installation, especially when used with Hertz amplifiers.

Speaker cable recommendations

The table refers to continuous power into 4 Ω load. If load decreases, cable size will have to increase proportionally.

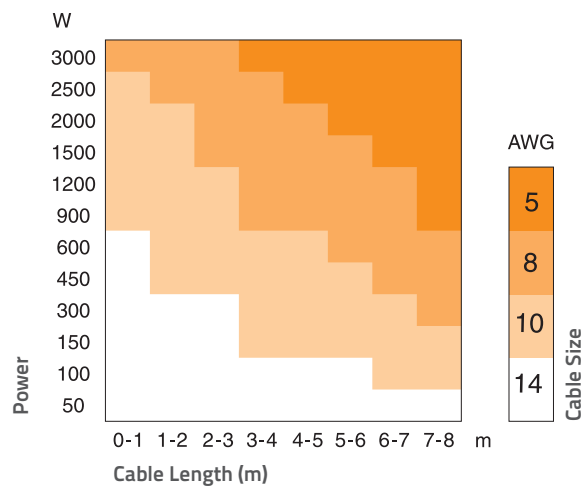

Power and Ground cable recommendations

If you don't know your system current consumption, find it using the mathematical formula below and find this same value on the left hand column of the table. Then calculate the length of your connection and find this same value on the bottom column of the table. At the point where these two values cross is the minimum section in gauge (A.W.G.) which Connection recommends for building a high performance, reliable system.

How to calculate your system current consumption

$$I = \frac{TP \times 2}{V_{batt}}$$

I = Current consumption of your system in ampere (A);

TP = Total power (RMS) of channels of all amplifiers in your system;

V_{batt} = Usually value is 12 V, the nominal automotive electrical system voltage.

Example:

- Your total system power (RMS) of all channels in all amplifiers is a combined 650 W.
- Your amplifier average is 50% efficiency, as most amplifiers today.
- Your electrical system is 12 V.

$$I = \frac{650 \times 2}{12} = 108,3 \text{ A Current consumption}$$

Power & Ground cable calculation table									Cable Size	
Minimum gauge size recommended for MAINPOWER & POWER FLOW cables. MAINPOWER cables ensure higher instantaneous current transfer.									A.W.G.	mm ²
240-350									1/0	53,5
180-240									2	33,6
150-180									4	21,2
120-150									8	8,4
100-120									10	5,3
80-100									12	3,3
60-80									14	2,1
40-60									16	1,3
20-40									18	0,8
8-20										
0-8										
	0-1	1-2	2-3	3-4	4-5	5-6	6-7	7-8		

12. BLOCK DIAGRAM

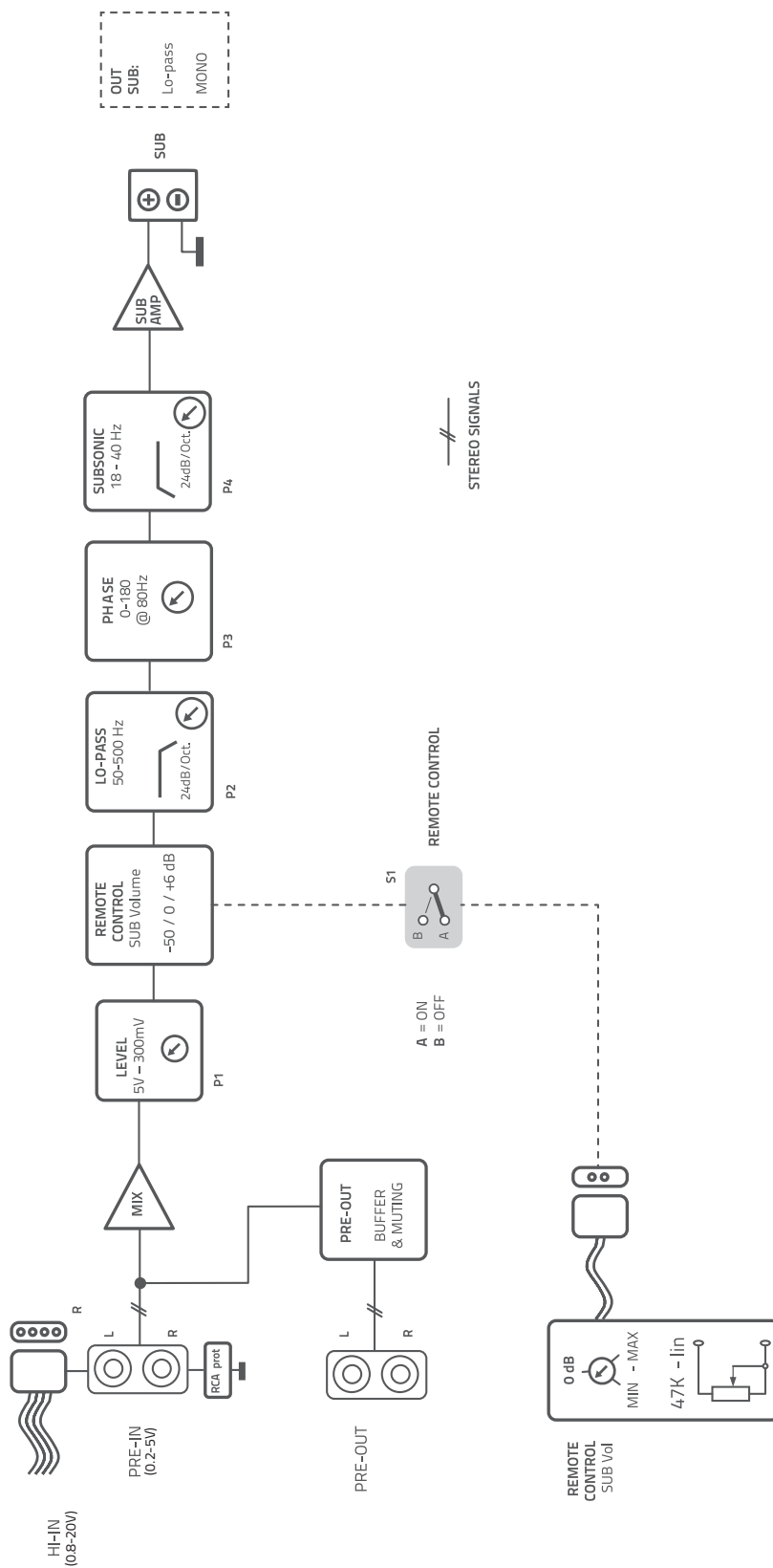

13. TECHNICAL SPECIFICATIONS

Power Supply	
Power supply voltage / fuse:	11÷15 VDC
Idling current:	2 A
Idling current when OFF:	0.04 mA
Consumption @ 1Ω, 14.4 VDC (Max Musical Power):	83,5 A
Remote In:	4 ÷ 15 VDC - 1 mA
ART™:	Automatic Remote Turn-On/Off with Speaker-In
Fuse:	3 x 40 A

Amplifier Stage	
Distorsion - THD (100 Hz @ 4Ω):	0.08 %
Bandwidth (-3 dB):	18 ÷ 500 Hz
S/N Ratio (A weighted @ 1 V):	105 dB
Damping factor (100 Hz @ 4Ω):	100
Pre-In sensitivity:	0.2 ÷ 5 V RMS
Pre-In impedance:	15 kΩ
Speaker-In sensitivity:	0.8 ÷ 20 V RMS
Speaker-In impedance:	470 Ω
Load impedance (MIN) @ 1 Ch:	4 ÷ 1Ω:
Output Power (RMS) @ 14.4 VDC, THD 1%:	
1 Ch:	600 W x 1 (4Ω)
1 Ch:	1000 W x 1 (2Ω)
1 Ch:	1000 W x 1 (1Ω)
CEA 2006-A Ratings:	
RMS Power (4Ω, ≤1 %THD+N, 14.4 V):	600 W x 1 Ch
S/N Ratio (ref. 1 W output):	83,5 dBA



Inputs / Outputs / Filter	
INPUTS:	PRE IN / SPEAKER IN
OUTPUTS:	Pre OUT
Filter: Lo-Pass:	50 ÷ 500 Hz @ 24 dB/Oct.
Phase:	(continuous adjustment) 0 ÷ 180°
Subsonic: Hi-Pass	18 ÷ 40 @ 24 dB/Oct.
Remote SUB Volume:	(-50 ÷ 6) dB

Size / Weight	
Max size (mm / in.):	349 x 170 x 46,7 / 13.74 x 6.69 x 1.84
Weight (kg / lb.):	3,09 / 6.81



All Specifications Subject to Change Without Notice

HERTZ

PART OF **ELETTROMEDIA** - 62018 Potenza Picena (MC) Italy - T +39 0733 870 870 - F +39 0733 870 880 - www.elettromedia.it